



# Buon Vino

2021-2022  
Wholesale Price List

PHONE 519-622-1166 TOLL FREE 1-855-522-1166  
EMAIL [orders@buonvino.com](mailto:orders@buonvino.com) WEBSITE [www.buonvino.com](http://www.buonvino.com)

## TABLE OF CONTENTS

Buon Vino Wine Filter Machines	2 - 3
Buon Vino Filter Pads	4 - 5
Buon Vino Replacement Parts	6
De-Gassing Equipment / Spoons	7
Corks / Cork Retriever / Bottle Stoppers	8 - 9
Bungs / Bottle Racks	10
Air Locks / Bottle Caps	11
Buon Vino Bottle Filling Equipment	12
Siphons / Books / Strainer	13
Bottles / Bags / Labels / Shrink Caps / Heat Shrink Machines Wine-On-Tap	14 - 15
Pitchers / Spigots	16
Tubing / Clamps / Funnels	17
Bottle Drippers / Avvinators	18
Brushes / Washers	19
Fermtech Ltd. Bottle Washers / Washing Accessories	20
Fermtech Ltd. Siphons / Bottle Fillers	21
Fermtech Ltd. Racking Tubes / Test Equipment	22
Corkers / Cappers	23 - 24
Hydrometers / Vinometers / Thermometers	24
Presses & Crushers	25
Chemical Products	26 - 27

Products may not always be exactly as shown.  
Prices may change without notice.  
Payment may be made by Visa or Mastercard.

### Mailing and Pick Up Address:

2 – 365 Franklin Blvd., Cambridge, ON N1R 8G7  
Open for Pick Up 8 AM – 4 PM Monday to Friday

~ PLEASE USE PRODUCT CODES WHEN ORDERING ~



PHONE 519-622-1166 TOLL FREE 1-855-522-1166

EMAIL [orders@buonvino.com](mailto:orders@buonvino.com) WEBSITE [www.buonvino.com](http://www.buonvino.com)



## WINE FILTERS

### Buon Vino MINI JET Wine Filter

MJM115NA

#### Quantity Discount

6  
12  
18

Wine filtration is the last step in the wine making process. The Buon Vino Mini Jet is manufactured with the home winemaker in mind. It is ideal for the customer who is filtering 1 or 2-23 litre batches at one time.

**NOTE:** *The Buon Vino Mini Jet is a filter NOT an electric bottle filler. Use of this unit for bottling will damage the pump and void warranty.*

**NOTE:** *Buon Vino Mini Jet is available with 220V Transformers EU Plug, UK Plug, AU Plug.*

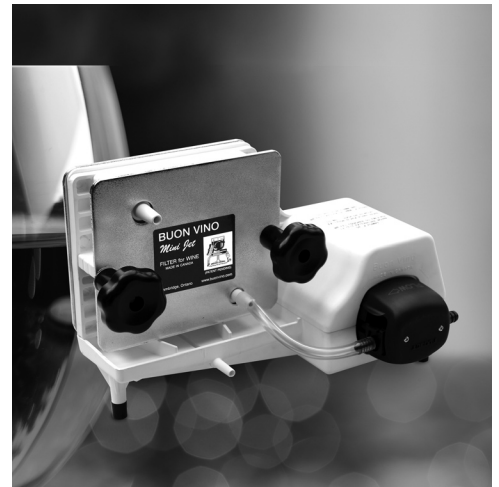

### Pre-Screen Filter – Mini Jet

PSFMJ

#### Screen Only

SCREEN

The Pre-Screen Filter can be attached to the intake hose on the Mini Jet to screen out large particles of sediment such as oak chips and/or seeds before they reach the pump.

MINI JET PRE-SCREEN FILTER 3/8" BARB



### Buon Vino SUPER JET Wine Filter

SJM

*Made for winemakers who make wine from grapes, berries or fresh juice and makes 40 Gal/year.*

**NOTE:** *Buon Vino Wine Filters are available with 220V Motors (for use outside of North America) upon request.*

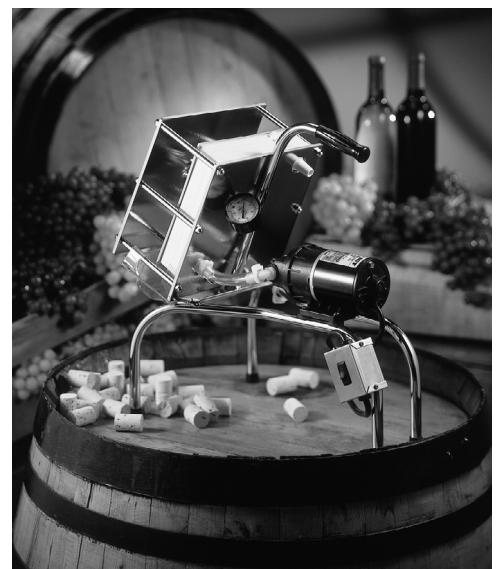



PHONE 519-622-1166 TOLL FREE 1-855-522-1166

EMAIL [orders@buonvino.com](mailto:orders@buonvino.com) WEBSITE [www.buonvino.com](http://www.buonvino.com)



## SEMI-INDUSTRIAL WINE FILTERS

### 10 Pad SEMI-INDUSTRIAL Wine Filter

10PAD

Includes Pre-Screen Filter

#### 10 Pad Wine Filter

24"h x 14"w x 15"l

- All Stainless Steel Filter Housing
- Averages 3 - 4 minutes / 23L batch
- Averages 15 - 20 batches / set of 10 pads
- Uses Buon Vino Super Jet Filter Pads



10 PAD WINE FILTER

### 6 Pad SEMI-INDUSTRIAL Wine Filter

6PAD

The 6 Pad Wine Filter looks and operates the same as the Buon Vino Super Jet 3 Pad. However, it has additional room for 3 more filter pads and a higher capacity pump.

*Tips on filtering - see page 5.*

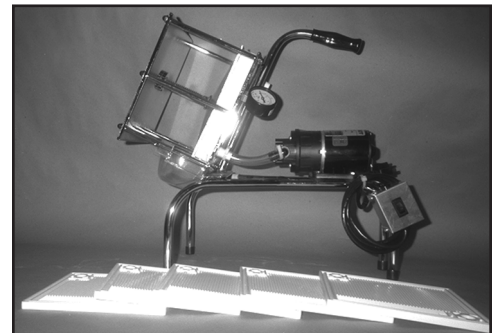

6 PAD WINE FILTER

### Pre-Screen Filter – Super Jet

PSFSJ

*Screen Only*

SCREEN

The Pre-Screen Filter can be attached to the intake hose on the Super Jet or Semi-Industrial Wine Filter to screen out large particles of sediment such as oak chips and/or seeds before they reach the pump. This should prolong the life of the Check Valve and allow you to maintain a much cleaner pump.



SUPER JET PRE-SCREEN FILTER 1/2" BARB

**NOTE:** *Buon Vino Wine Filters are available with 220V Motors (for use outside of North America) upon request.*



# Buon Vino

2021-2022  
Wholesale Price List

PHONE 519-622-1166 TOLL FREE 1-855-522-1166

EMAIL [orders@buonvino.com](mailto:orders@buonvino.com) WEBSITE [www.buonvino.com](http://www.buonvino.com)



## BUON VINO FILTER PADS

### SUPER JET Filter Pads:

*Full Case  
Discount*

Super Jet Filter Pads #1 - <i>coarse filtration</i>	SJ1DOZ
Super Jet Filter Pads #2 - <i>polish filtration</i>	SJ2DOZ
Super Jet Filter Pads #3 - <i>fine filtration .5M</i>	SJ3DOZ

NOTE: Full case discount means 5 Doz (60 pkgs) of the same grade of filter pads.  
Eg. 1 Full Case (5 Doz) of Super Jet #2 Filter Pads



### MINI JET Filter Pads:

#### Quantity Discount

Mini Jet Filter Pads #1 <i>coarse filtration</i>	MJ1DOZ
Mini Jet Filter Pads #2 <i>polish filtration</i>	MJ2DOZ
Mini Jet Filter Pads #3 <i>fine filtration</i>	MJ3DOZ

<i>per dozen</i>	<i>25 doz total</i>	<i>50 doz total</i>
------------------	-------------------------	-------------------------

NOTE: Grade of pads are proportional to the Buon Vino Filter Systems. The co-ordination of Buon Vino Filter Machine and Buon Vino Filter Pads will give you optimum results.

~ PLEASE USE PRODUCT CODES WHEN ORDERING ~



# Buon Vino

2021-2022  
Wholesale Price List

PHONE 519-622-1166 TOLL FREE 1-855-522-1166

EMAIL [orders@buonvino.com](mailto:orders@buonvino.com) WEBSITE [www.buonvino.com](http://www.buonvino.com)



## BUON VINO FILTER PADS *(cont'd)*

### Round Filter Pads:

*Per Case of 100*

*Each*

BV AF 1	BVAF1CS .....	BVAF1EA
BV AF 2	BVAF2CS .....	BVAF2EA
BV AF 3	BVAF3CS .....	BVAF3EA

Buon Vino Round Filter pads, are packaged loose in cases of 100.  
Please note that in order to maintain the 100/case price, you must order 100 of the same type of filter pad.

### Bulk SUPER JET Filter Pads:

*Per Case of 200*

*with Holes (Super Jet)*

Filter Pads #1 .....	SJ1LOOSE
Filter Pads #2 .....	SJ2LOOSE
Filter Pads #3 .....	SJ3LOOSE
Filter Pads S-250 ~ with holes .....	S250LOOSE

*This pad is more coarse than a #2 Filter Pad (Ideal for Beer)*

### Bulk NO-HOLE Filter Pads:

*Per Case of 200*

*No Holes*

Filter Pads #1 - No holes .....	FP1NOHOLE
Filter Pads #2 - No holes .....	FP2NOHOLE
Filter Pads #3 - No holes .....	FP3NOHOLE
Filter Pads SR - No holes .....	SRNOHOLE

*This pad is more coarse than a #2 Filter Pad (Ideal for Beer)*



## REPLACEMENT PARTS

### Buon Vino SUPER JET Replacement Parts:

Check Valve & Seal Ring - 3 Pad, 6 Pad and 10 Pad - provide Pump Model Number when ordering	CKVALVE
Gauge (30 P.S.I.)	GAUGE30
60 PSI Glycerine Gauge - 10 Pad	GAUGE60
Inlet & Outlet Hose Set	HOSESJ
Antisediment Tip	TIPSJ
Hose Clamp	CLAMPSJ
Drip Tray & Deflector	DRIPTRAY
Plastic Plate with Fins	PLATESJF
Plastic Plate with Nozzles	PLATESJN
Plastic Plate – Central	PLATESJC

### Repairs and Returns

- Repairs will be done only through Buon Vino or Authorized Locations.
- Please call prior to sending us your machine, as we may be able to offer suggestions or repair tips over the phone.
- Returns must be authorized by Buon Vino.
- Buon Vino does not accept collect shipments on returns.
- Rental of either the Buon Vino Mini Jet or the Buon Vino Super Jet, renders the warranty null and void.



### Buon Vino MINI JET Replacement Parts:

3-Piece Hose Set	HOSEMJ
Inlet Fitting 3/8"	FITMJ38
Outlet Fitting 1/4"	FITMJ14
Stainless Steel Bolts	SSBOLTMJ
Handwheel	HANDWHEEL
Foot Pad	
Antisediment Tip	TIPMJ
Plastic Plate with Nozzles	PLATEMJN
Plastic Plate – Central	PLATEMJC



## DE-GASSING EQUIPMENT

### **FIZZ<sub>x</sub> Wine Agitating Rod**

FIZZ<sub>x</sub>

One of the most important parts of wine making is removing the gas after fermentation. De-gassing insures faster and more effective clearing and aging.

The Fizz<sub>x</sub> wine agitating rod eliminates the hassle of shaking and stirring. It also makes filtration an easier task.

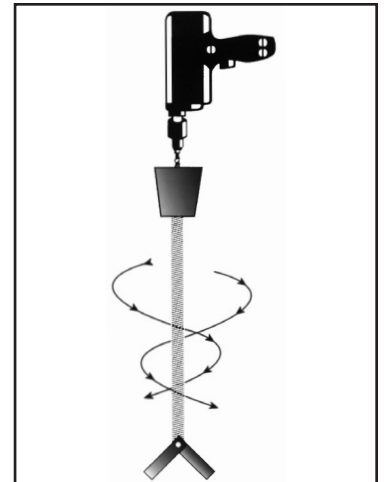

**FIZZ<sub>x</sub> WINE AGITATING ROD**

### **Fermtech Ltd. The Whip**

WP01

Powerful mixer degasses your wine quickly and easily.  
Removes carbonation.

### **Beer & Wine Spoon**

28" Plastic Spoon w/Paddle (70 cm)

SPOON

#### **Compatibility and Quality**

*When buying filter machines and filter pads, look for the Buon Vino trademark to assure compatibility & quality for filtering.*

**Use Original Buon Vino Filter Pads**





## CORKS ~ CORKS ~ CORKS

### CORKS ~ Agglomerated:

#9 Agglomerated - 7/cs	Short (38 x 23)	CORKA9S
#9 Agglomerated - 6/cs	Long (44 x 23)	CORKA9L
#8 Agglomerated - 6/cs	Long (44 x 22)	CORKA8L

### CORKS ~ Natural:

#9 Natural <i>Straight</i> - 6/cs	Short (38 x 24)	CORKN9S
#9 Natural <i>Straight</i> - 5/cs	Long (45 x 24)	CORKN9L
#8 Natural <i>Straight</i> - 6/cs	Short (38 x 22)	CORKN8S

Buon Vino's Natural and Agglomerated Corks are pre-packaged in bags of 1000 and are sealed with S<sub>02</sub> gas to assure quality.

### Synthetic Corks:

Extruded Synthetic Cork #8	Long (44 x 22)	CORKESTR
----------------------------	----------------	----------

### How To Determine a GOOD Agglomerated Cork:

- The shavings that form the Agglomerated Cork are uniform in size and texture.
- There is a little give to the Agglomerated Cork when you depress against the side.
- The Agglomerated Cork should absorb no more than 1/8" of wine after being inserted into the bottle.







PHONE 519-622-1166 TOLL FREE 1-855-522-1166  
EMAIL [orders@buonvino.com](mailto:orders@buonvino.com) WEBSITE [www.buonvino.com](http://www.buonvino.com)

## CORKS ~ CORKS ~ CORKS

### Miscellaneous Corks:

Tapered Corks	(32 x 22 x 19)	CORKTAPE
Demijohn Corks 15L	(37 x 36 x 32)	CORK15
Demijohn Corks 25L	(38 x 44 x 34)	CORK25
Demijohn Corks 54L <i>Natural</i>	(45 x 55 x 44)	CORK54DS
Demijohn Corks 54L <i>Agglo</i>	(45 x 55 x 44)	CORK54AG
Demijohn Corks 54L <i>W/Hole-Natural</i>	(43 x 55 x 45)	CORK54DB
Gallon Corks	(33 x 32 x 27)	CORKGALL
Carboy Corks (18.9L & 23L)	(40 x 39 x 28)	CORKCARS
Carboy Corks (18.9L & 23L) <i>W/Hole</i>	(40 x 39 x 28)	CORKCARB
Agglo Carboy Corks (18.9L & 23L)	(40 x 39 x 28)	CORKCARA

### Bottle Stoppers and Reclosures: *For Short Term Storage Only*

Expansion Locks - 100/bag		EXPLOCK
	<i>less than 100</i>	
Corks with Plastic Cap	(27 x 19)	CORKWPC

### Cork Retriever

*To remove a cork that has been pushed into bottle*

CORKRET



**Carboy Corks fit most  
20L & 25L Demijohns  
11L, 18.9L & 23L  
Carboys**



EXPANSION  
LOCK

CORKS WITH  
PLASTIC CAP



## BUON VINO BUNGS / BOTTLE RACKS

### Buon Vino BUNGS:

*Manufactured by Buon Vino*

#### SMALL

~ Fits 11L, 18.9L  
and 23L Carboys

**Bored Solid**

**BUNGSMB BUNGSMS**

#### MEDIUM

~ Fits 20L, 25L  
and 34L Demijohns

**BUNGMDB BUNGMS**

#### INTERMEDIATE

~ Fits Plastic Carboys

**BUNGINB BUNGINS**

#### LARGE

~ Fits 54L Demijohns

**BUNGLGB BUNGLGS**

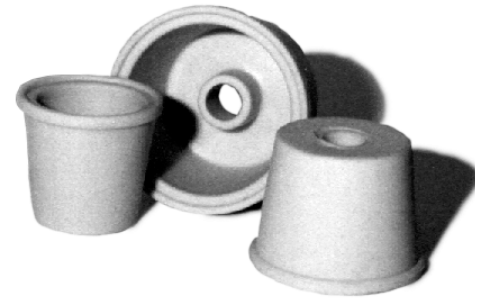

<ul style="list-style-type: none"> <li>• Lip prevents <b>Bung</b> from falling into Carboy</li> <li>• 4 convenient sizes results in LESS inventory</li> <li>• Longer taper produces snugger fit and better seal</li> <li>• Fits Cylinder and 'S' Type Fermentation Locks</li> <li>• Available as solid or with hole</li> </ul>	
--	--



### Bottle Racks:

30 Place Bottle Racks - *Painted*

**BOTRAC30P**

50 Place Bottle Racks - *Painted*

**BOTRAC50P**

100 Place Bottle Racks - *Painted*

**BOTRAC100**

Wein Crates - *Black Plastic, Stackable*

*Holds 6 bottles, Interlocking*

**CRATE**



WEIN  
CRATE



PHONE 519-622-1166 TOLL FREE 1-855-522-1166  
EMAIL [orders@buonvino.com](mailto:orders@buonvino.com) WEBSITE [www.buonvino.com](http://www.buonvino.com)

## AIR LOCKS / CAPS

### Buon Vino AIR LOCKS: *Manufactured by Buon Vino*

Cylinder Air Lock	<b>BVAIRLOCK</b>
<i>Quantity Discount</i>	<i>Case of 200</i>
'S' Type Air Lock 100/bag	<b>SAIR</b>



### Caps:

Crown Caps	
- 100/bag	<b>CROWNCAPBG</b>
- Case (50 bags 100/bag)	<b>CROWNCAPCS</b>
PET Caps	
- for plastic PET bottles	<b>PETCAPBG</b>
- Case (3500 PET caps)	<b>PETCAPCS</b>
Screw Caps	
- White - for 750ml glass bottles	<b>SCREWCAP</b>
Black Poly-Seal Screw Cap	
- Large - 100/bag	<b>BLKCAPLG</b>
<i>Fits 4L/Gallon Glass Jugs</i>	<i>less than 100</i>
Black Poly-Seal Screw Cap	
- Small	<b>BLKCAPSM</b>
<i>Fits 750ml bottles</i>	
Plastic Champagne Stoppers - 100/bag	<b>CHAMPAGNE</b>
Wire Hoods - packed in plastic sleeves	<b>WIREHOOD</b>

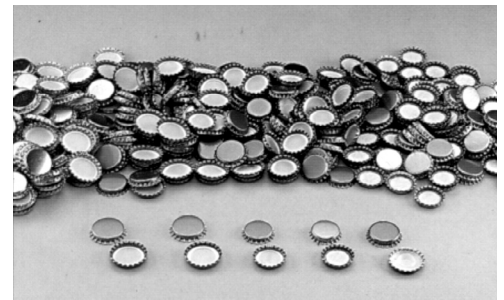

EXPANSION LOCKS  
(SEE PAGE 9)





PHONE 519-622-1166 TOLL FREE 1-855-522-1166

EMAIL [orders@buonvino.com](mailto:orders@buonvino.com) WEBSITE [www.buonvino.com](http://www.buonvino.com)



## BOTTLE FILLING EQUIPMENT



### Electric Bottler Filler

Table Top Model

FJTT

Developed to make your wine filling needs easier, the Buon Vino Fill Jet Electric Bottle Filler is capable of filling a 750ml bottle in just 17 seconds. It's specially designed tapered tip cascades wine into the bottle, and the pump is self de-activating to help prevent overflows. These fillers can be used anywhere, with its self-priming pump and spring loaded bottle base – they are fast and easy to use.

Nozzle Cone

CONEFJ

Nozzle Tip

TIPFJ

Tube Set - with overflow

HOSEFJ

Plastic Bottle Holding Plate Cover

- for Floor Model ~ Solid or w/Hole

- for Table Top Model

Pump Only

MOTORFJ

Replacement Head

- for Table Top & Floor Model Fill Jet HEADFJ



TABLE TOP MODEL



REPLACEMENT HEAD

### Super Automatic Bottle Filler

SABF

- Gravity Filler
- Automatically stops at same level every time
- Easy to start, doesn't need to be restarted
- Doesn't drip, mess free!!!
- Featured in "The Encyclopedia of Home Winemaking"  
Pierre Drapeau & Andre Vanasse

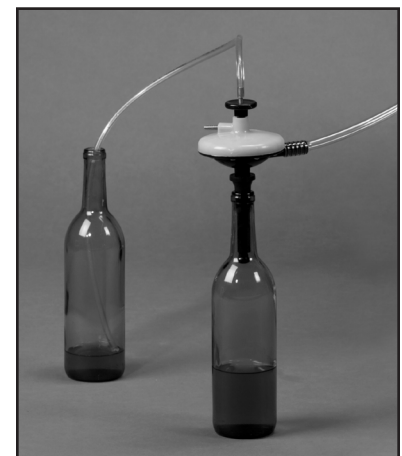



PHONE 519-622-1166 TOLL FREE 1-855-522-1166  
EMAIL [orders@buonvino.com](mailto:orders@buonvino.com) WEBSITE [www.buonvino.com](http://www.buonvino.com)

## SIPHONS / BOOKS / STRAINER

### Siphons:

Siphon <i>with Butterfly Tap</i>	SIPHONBT
Siphon <i>with Push Tap</i>	SIPHONPT
Siphon <i>with Bellow and Butterfly Tap</i>	SIPHONBBT
Mini Siphon - <i>Extendable</i>	SIPHONMI
Butterfly - <i>Tap Only</i>	SIPHONBO
Mini Butterfly - <i>Tap Only</i>	SIPHONMB

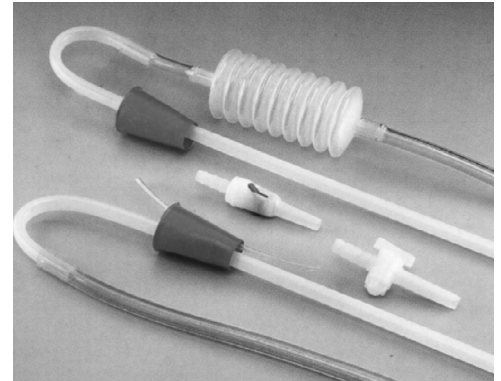

A-BELLOW; B-PUSH TAP;  
C-BUTTERFLY TAP

**See more Siphons & Bottle Fillers on page 21.**

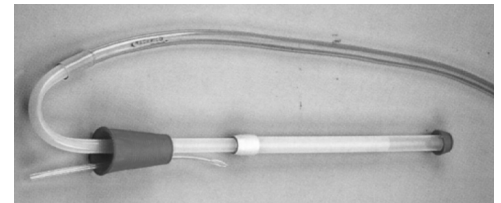

MINI SIPHON

### Home Winemaking Books:

*"The Winemakers Answer Book"*

Alison Crowe—Columnist for *WineMaker* BOOKANSW

### Must Strainers:

Must Strainer - <i>Cestello Cola mosto fits in No. 30 &amp; No. 35 funnels</i>	MUSTSTR
--	---------

MUST STRAINER

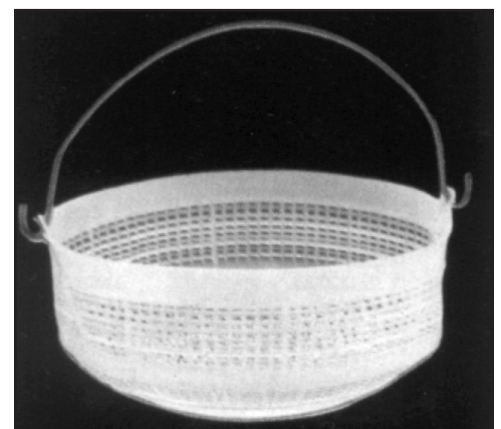



PHONE 519-622-1166 TOLL FREE 1-855-522-1166  
EMAIL [orders@buonvino.com](mailto:orders@buonvino.com) WEBSITE [www.buonvino.com](http://www.buonvino.com)

## BOTTLES

### ITALIAN GLASS DEMIJOHNS: *With Plastic Cover*

20L Glass Demijohn	DEMI20
25L Glass Demijohn	DEMI25
54L Glass Demijohn	DEMI54
54L Glass Demijohn with Tap	DEMT54

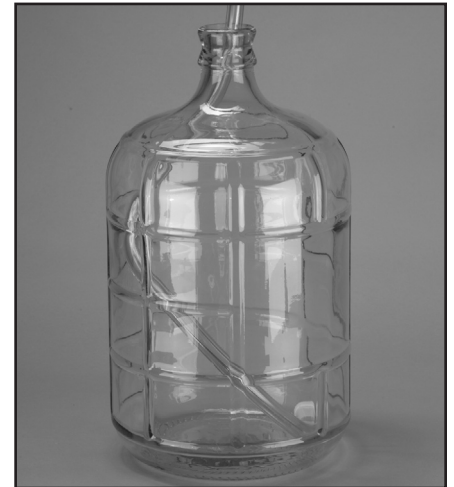

### ITALIAN GLASS CARBOYS:

11L Glass Carboy	CARBOY11
18.9L Glass Carboy	CARBOY18
23L Glass Carboy	CARBOY23
Carboy Handle	HANDLECAR

\*Prices subject change without notice. Please call or email to confirm prices.

### 375ml - 500ml Bottles:

<i>Description</i>	<i>Item Code#</i>	<i>Colour</i>	<i>Bottles / Case</i>	<i>Price / Case</i>
500ml Barbera - <i>Bartop Square Base</i>	500BARBAFL	Flint	12	
375ml Renana Breganza - <i>Bartop</i>	375RENBRGR	Green	12	
375ml Bordeaux - <i>Cork</i>	375BORDCGR	Green	24	
375ml Bordeaux - <i>Cork</i>	375BORDCFL	Flint	24	
375ml Hock - <i>Great for Icewine</i>	375HOCKCFL	Flint	12	
500ml Beer <i>PET</i>	500PETGR	Green	24	
500ml Beer <i>PET</i>	500PETFL	Flint	24	



BORDEAUX



SPARKLING



HOCK



BORDEAUX



CLASSIC HOCK



GALLON JUG

~ PLEASE USE PRODUCT CODES WHEN ORDERING ~



## BOTTLES & ACCESSORIES

### 750ml – 4L Bottles:

Description	Item Code#	Colour	Bottles / Case	Price / Case
750ml Bordeaux - Cork	750BORDCGR	Green	12	
750ml Bordeaux - Cork	750BORDCFL	Flint	12	
750ml Classic Hock - Cork	750HOCKCFL	Flint	12	
750ml Sparkling Wine	750SPARKGR	Green	12	
750ml Bordeaux - Screw Top	750BORDSFL	Flint	12	
1L Bordeaux - Cork	1LBORDCGR	Green	12	
1.5L Bordeaux - Cork	15BORDCGR	Green	6	
1.5L Bordeaux - Cork	15BORDCFL	Flint	6	
2L Growler	2LGLJUGAM	Amber	6	
4L Glass Jug	4LGLJUGFL	Flint	4	

\*Prices subject change without notice. Please call or email to confirm prices.

### Shrink Caps

SHRINKCAP

### Heat Shrink Machines

HEATSHRINK

### 1.5L Wine Bag

*Barrel Style*

15WINEBAG



### Wine On Tap Holds 7L

*A'Pour*

*Replacement Bags - 3 per pack*

WT01

WT03

WT02





PHONE 519-622-1166 TOLL FREE 1-855-522-1166  
EMAIL [orders@buonvino.com](mailto:orders@buonvino.com) WEBSITE [www.buonvino.com](http://www.buonvino.com)

## PITCHERS / SPIGOTS

### Plastic Pitchers:

500ml	Plastic Pitcher	PP500M
1L	Plastic Pitcher	PP1L
3L	Plastic Pitcher	PP3L
5L	Plastic Pitcher	PP5L



PLASTIC PITCHERS

### Spigots:

Wooden Spigot with Wood Key	SPIGOTWK
Plastic Spigot with nut - <i>Small Spout</i>	SPIGOTPSS
Plastic Spigot with nut - <i>Large Spout</i>	SPIGOTPLS



PLASTIC SPIGOT

### Pouring Drop Stop:

Red	DROPSTOP
-----	----------



POURING DROP-STOP





## TUBING / CLAMPS / FUNNELS

### Clear Plastic Tubing: *F.D.A. Clear Vinyl*

*per 100ft box*

1/2" x 1 1/16" - Super Jet	TUBING1
1/2" x 5/8" - Siphon	TUBING2
3/8" x 1/2" - SABF & New Style Mini Jet	TUBING3
1/4" x 3/8" - Old Style Mini Jet Inlet & Drip	TUBING4
5/16" x 7/16" - Old Style Mini Jet Outlet	TUBING5
3/4" x 1"	TUBING6
3/8" x 5/8" - Fill Jet	TUBING7
3/16" x 5/16" - Fill Jet Overflow	TUBING8
7/16" x 9/16"	TUBING9

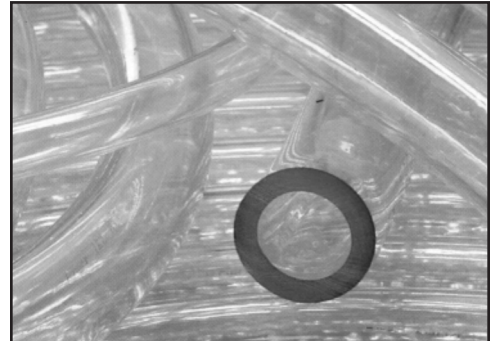

*Tubing is boxed in 100ft rolls and may be purchased per box or per foot. 5¢ per foot extra for cut lengths.*

### Tubing Shut Off Clamp:

Small Shut Off Clamp - 12 position - 7/16" tubing **CLAMP5M**

Large Shut Off Clamp - 12 position - 1/2" tubing **CLAMP1G**

### Funnels:

No. 12 (4.5")	FUNN12
No. 15 (6")	FUNN15
No. 18 (7")	FUNN18
No. 21 (8")	FUNN21
No. 25 (10")	FUNN25
No. 30 (12")	FUNN30
No. 35 (14")	FUNN35
Spiral Funnel (12")	FUNNSP



SPIRAL  
FUNNEL



### Self Leveling Funnel: **FUNNSL**

Ideal for bottling. Simply place self-leveling funnel in empty bottle, fill funnel with wine. The funnel will only fill to the level you set. Then you simply pull up the lever and continue to your next bottle. Quick, easy and simple!



## BOTTLE DRIPPERS / AVVINATORS

### FERRARI® Eco. Heavy Duty Bottle Drippers:

*Threaded Pegs - Unit Screws Together*

45 Place Bottle Dripper - Ferrari DRIP45

81 Place Bottle Dripper - Ferrari DRIP81



FERRARI® BOTTLE DRIPPER

### FERRARI® Rotating Bottle Drippers:

45 Place ROTATING Bottle Dripper - Ferrari DRIPROT45

90 Place ROTATING Bottle Dripper - Ferrari DRIPROT90

### Gocciolino Small Bottle Drainer:

Single/Stackable DRIP1

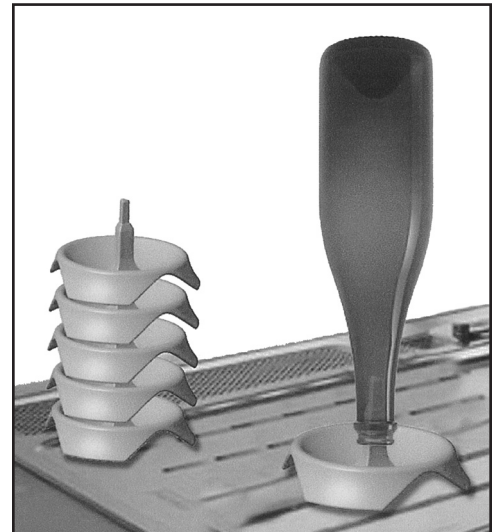

GOCCIOLINO SMALL BOTTLE DRAINER

### Avvinators / Bottle Rinsers:

FERRARI Avvinator - Red bowl; AVVRB

FERRARI Avvinator - Clear bowl  
Includes bottle dripper adapter AVVCB



## BRUSHES / WASHERS

### Brushes:

16" Bottle Brush	BRUSH16
21" Brush - For Gallons and Small Jugs	BRUSH21
28" Brush - For Carboys and Small Demijohns	BRUSH28
38" Brush - For 54L Demijohns	BRUSH38

### Turbo Brush:

Attaches to hand-held drill	BRUSHTURBO
-----------------------------	------------

### Bottle Washers:

JET Carboy Bottle Washer - Brass	JETCARBOY
Buon Vino SPRAY Wand Brass tap connection Manufactured by Buon Vino	SPRAY

See more Bottle Washers page 20.

### Multi-Use 16-Bottle Rack:

1 Rack – 3 Uses: Sterilize, Rinse, Portable Rack	3IN1
---	------

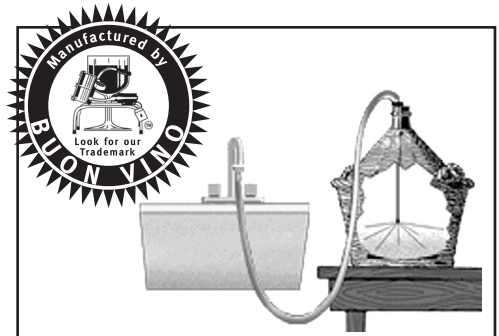

### Buon Vino SPRAY Wand

- Cleans Carboys quickly and effortlessly
- Attaches easily to laundry faucet with BRASS connection
- Creates high pressure water
- Sprays in all directions simultaneously



### Turbo Brush

- Attaches easily to your hand-held drill
- Effortlessly cleans large carboys



MULTI-USE 16-BOTTLE RACK



## Fermtech Ltd. BOTTLE WASHERS / WASHING ACCESSORIES

### Bottle Washers:

The Blast Washer

**BW01**

Automatic operation - press to rinse, lift to stop.  
Easy on plumbing - eliminates water-hammer damage.  
Durable enough for commercial use.  
Use nozzle to rinse siphons and filters. Hot or cold water.



**BW01**

The Double Blast Washer

**BW02**

Includes a quick connect system for easy hook-up.  
Wide base provides stable operation in any sink  
and eliminates stress on any faucet.  
Temperature resistant to 140°F.



**BW02**

Spare Parts

The Double Blast Washer

Spray Nozzle Set - 2 small, 1 large

**BW02-01**

Female Quick Connect - with brass nut

**BW02-02**

Male Quick Connect - with hose

**BW02-03**

**BW02-02**

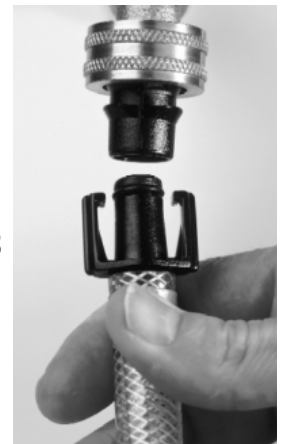

**BW02-03**

### Bottle Washing Accessories:

Kitchen Faucet Adapter

**BW03**

Durable nickel-plated brass.  
Dual kitchen faucet thread fits most faucets.

Quick-Connect Utility Hose

**BW04**

Includes 5' of 1/2" vinyl hose and  
1 male connector.  
For general rinsing and filling.  
For use with The Double Blast  
Washer (BW02) only.

**BW04**





## Fermtech Ltd. SIPHONS / BOTTLE FILLERS

### Siphons:

#### The Auto Siphon

Start a siphon with a single stroke. Works in carboys and pails with as little as a few inches of liquid. Precision designed for smooth operation and no leaks. Racking tube included.

<i>Mini (14" long)</i>	SE10
<i>Regular - for 3/8" siphons (22" long)</i>	SE01
<i>High Capacity - for 1/2" siphons (25" long)</i>	SE02

#### Spare Parts

Centre tube/seal - <i>Regular 3/8"</i>	SE0101
Centre tube/seal - <i>High Capacity 1/2"</i>	SE0201

#### Auto Siphon Clamps

Fits - <i>3/8" and Mini</i>	SE11
Fits - <i>1/2"</i>	SE12



### Bottle Fillers:

Top quality. No Springs means hands-off filling: pick-up to stop. Sensitive tip is designed to allow the customer to top up the bottle if desired.

#### The Siphon Valve

Most popular size for wine and beer.  
Its 3/8" clear acrylic tubing fits a standard 5/16" x 7/16" hose.

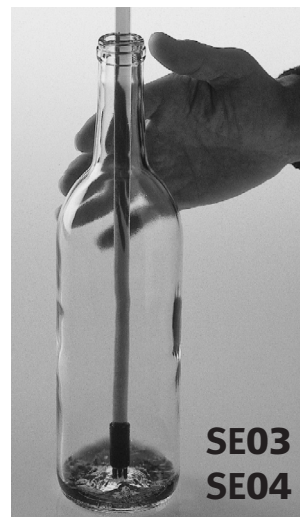

#### ProFiller

ProFiller is 20% to 25% faster. 3/8" clear acrylic tubing. Handy clip can be used to interrupt flow.

#### The Wine Filler

High capacity filler for the volume wine maker (25 bottles in 8 minutes). Its 1/2" acrylic tubing fits a 7/16" x 9/16" siphon hose.



#### The Whip

Powerful mixer degasses your wine quickly and easily.  
Removes carbonation.



## Fermtech Ltd. RACKING TUBES / TEST EQUIPMENT

### Racking Tubes:

Arguably the best racking tubes available, these clear acrylic tubes are a perfect accompaniment to our bottle fillers. They are carefully bent at the top with a press-on style anti-sediment tip. These tips will not fall off with repeated use.

3/8" dia. x 24" long (19L/5 US Gal carboy)	SE05
3/8" dia. x 30" long (23L/6 US Gal carboy & demijohn)	SE06
1/2" dia. x 30" long (23L/6 US Gal carboy & demijohn) rack 5 Gal in 3 minutes	SE07

Racking Tube Clamps	3/8" SE08
<i>This unique spring loaded clamp holds the racking tube in place during siphoning Universal design fits carboys, pails and jugs.</i>	1/2" SE09

Racking Tube Tips	3/8" SE0501
	1/2" SE0701

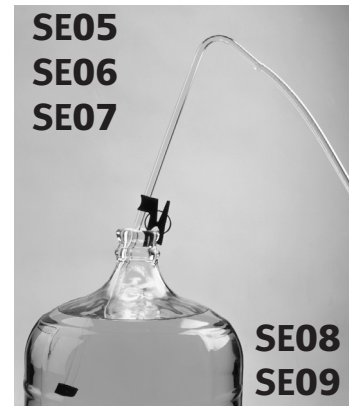

### Test Equipment:

The Thief - 19" long	TE01
Acrylic for excellent clarity. Easy to clean.	
1. Dip for a quick sample	
2. Place your standard hydrometer directly into The Thief	
3. Touch tip against container to empty The Thief	
Hydrometer Sample Jars	10" TE02
<i>Acrylic for excellent clarity, securely bonded to an impact-resistant base</i>	12" TE03
	14" TE04





## CORKERS

### Hand Corkers:

Easy Twin Lever Corker - *Ferrari*  
*2 lever corks made easier for bottling*

CORKERTWI



EASY TWIN LEVER  
CORKER

### Floor Model Corkers:

Large Model Floor Corker - *Brass Jaws*  
*Red Model - 36" High*

CORKERLGR

Small Model Floor Corker - *Plastic Jaws*  
*Burgundy - 31" High*

CORKERSMM

Small Model **Deluxe** Floor Corker  
*35" High (Burgundy)*

CORKERSMD

*NOTE: The small Model Floor Corker and the Small Model Deluxe Floor  
Corker are the same style, except the DELUXE model stands higher.*

Corker Feet

*for Small and Small Deluxe Floor Corkers*  
*each corker uses 3 feet*

CORKERFEET

Plastic Bottle Holding Plate Cover

*for Small and Small Deluxe Model Corkers*

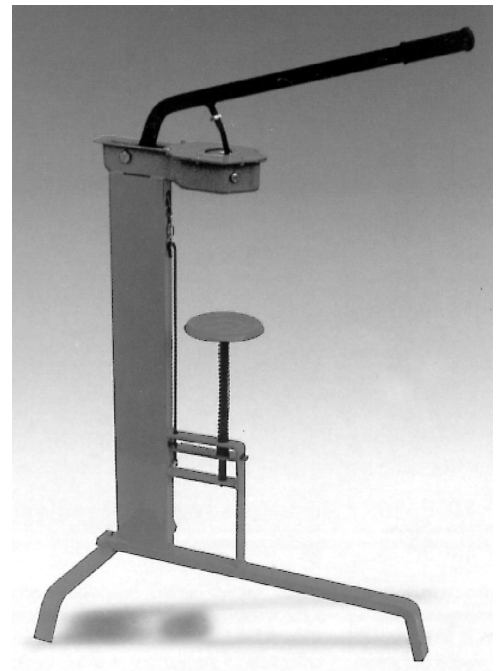

LARGE MODEL FLOOR CORKER



PHONE 519-622-1166 TOLL FREE 1-855-522-1166  
EMAIL [orders@buonvino.com](mailto:orders@buonvino.com) WEBSITE [www.buonvino.com](http://www.buonvino.com)

## CORKERS /CAPPERS / WINE INSTRUMENTS

### Bench Corker and Cappers:

Emily Capper by FERRARI®

CAPPEREMI

2000 Semi-Automatic Bench Capper

CAPPER2000

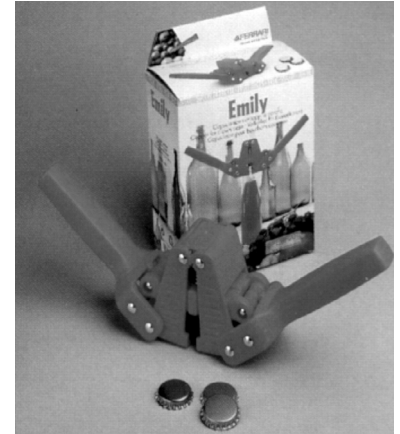

'EMILY' CAPPER

### Hydrometers & Vinometers:

Econo Triple Scale Wine Hydrometer

HYDROMECH

Triple Scale Wine Hydrometer

HYDROMTS

Vinometer - *To measure alcohol*

VINOMETER

Thermometer - *Floating*

THERMOMETE

Test Stands - see our complete line of  **Fermtech** Ltd. products page 20-22.



2000 SEMI-AUTOMATIC BENCH CAPPER





## PRESSES & CRUSHERS

**Presses:** *Press Number corresponds to diameter in centimeters of the basket.*

- |        |         |
|--------|---------|
| No. 15 | PRESS15 |
| No. 20 | PRESS20 |
| No. 25 | PRESS25 |
| No. 30 | PRESS30 |
| No. 35 | PRESS35 |
| No. 40 | PRESS40 |
| No. 45 | PRESS45 |

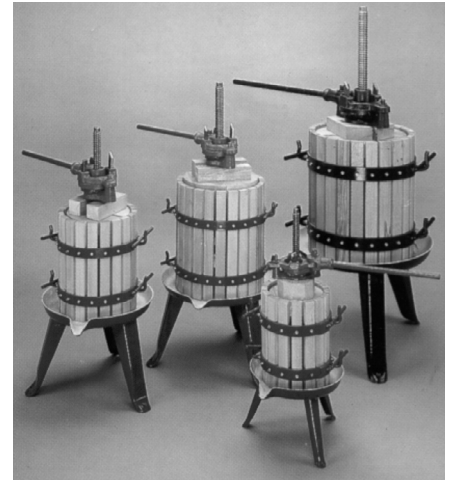

PRESSES

### Crushers:

- Manual Stainless Steel Crusher Double Roller **CRUSHERWA**  
- *w/agitator*
- Manual Stainless Steel Crusher Double Roller **CRUSHERNA**  
- *no agitator*
- Electric Crusher **DESTEMER** .... *special order*

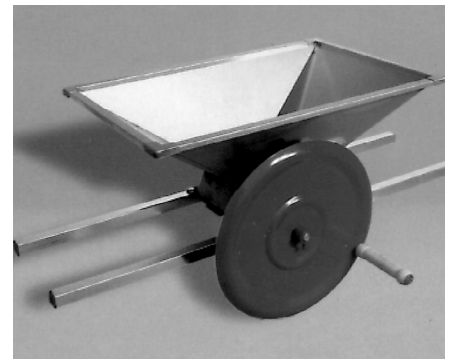

CRUSHER

### Vertical Bladder Fruit Presses:

- Internal bladder expands with water or air*
- No. 20L Capacity ..... *special order*
  - No. 40L Capacity ..... *special order*
  - No. 80L Capacity ..... *special order*
  - No. 160L Capacity ..... *special order*
  - No. 300L Capacity - *all stainless steel* ..... *special order*

*Buon Vino also distributes large Industrial Grape Presses & Destemmers  
Call us for details!*

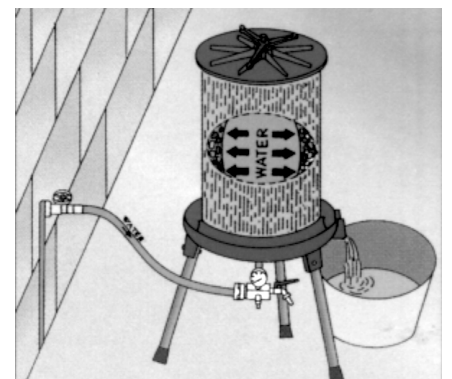

BLADDER PRESS



## CHEMICAL PRODUCTS

### Acids:

Citric Acid	<i>Acido Citrico</i> . . . . .	CHEMCITACD
Ascorbic Acid - Vitamin C	<i>Acido Ascorbico</i> . . . . .	CHEMASCACD
Metatartaric Acid	<i>Acido Metatartarico</i> . . . . .	CHEMMETACD
Tartaric Acid	<i>Acido Tartarico</i> - 1 kg bags. .	CHEMTAACKG

### Cleaning & Sanitation:

Potassium Metabisulphite	1 kg . . . . .	CHEMPOTMET
<i>Powder form</i>	25 kg bag . . . . .	CHEMPOTMBG
	250 gram bag . . . . .	CHEMPOTPKG
Destainex	1 kg . . . . .	CHEMDESTNX
	<i>Highly recommended cleaning 5 kg bag agent for all Buon Vino products</i>	
Neo-Detersol Verde		
	<i>Cleaning agent for glass</i> . . . . .	CHEMNEODET
Sulphur Discs / Zolfo		
	<i>approx. 100 discs</i> 1 kg box . . . . .	CHEMSULPHE

### Stabilizing Agents:

Tannisol - Tablet stabilizer	10 tablets/pkg . . . . .	CHEMTANNTU
	1 kg - 10 pkg/kg . . . . .	CHEMTANNIS
Sorbosol - Excellent stabilizer	. . . . .	CHEMSORBOS
Potassium Sorbate - <i>Sorbato di Potassio</i>	. . . . .	CHEMPOTSOR

### Wine Conditioners:

C.C. Wine Conditioner	1.5L box . . . . .	CHEMCC
	<i>Pure concentrated grape must sugar. Contains NO liquid invert sugar.</i>	



## CHEMICAL PRODUCTS *(cont'd)*

### Clarifying Agents:

Neo-Clar - <i>Ideal clarifying agent for Red &amp; White wines</i>	CHEMNEOCLA
Bentonite 50 lbs / bag	CHEMBENTON
Gelatin - <i>Pulvi Clar S</i>	CHEMGELATI
Tannin - <i>Tannino Blanc (Formerly Tannino Etere)</i>	CHEMTANETE

### Yeast & Yeast Nutrients:

Yeast - <i>5 gm packages (100 packages per box)</i>	CHEMYEASTP
Nutrifer Vit - <i>Yeast nutrient</i>	CHEMNUTRIV
Ammonium Phosphate	CHEMAMMPHO

### Antiflor / Florstop: *To prevent film from forming on wine*

Antiflor Tablets - <i>For demijohns Prevents film on top of wine 12 tablets/pkg - 40 pkgs/box</i>	CHEMANTIPK CHEMANTIFL
Antiflor - <i>For barrels - Fusti 2 tablets/pkg - 40 pkgs/box</i>	CHEMANTFUP CHEMANTIFU
Flor Stop - <i>For vats - Vasche 1 tablet/pkg - 40 pkgs/box</i>	CHEMANTIVA

### Miscellaneous:

Anticase F.N. - <i>To treat oxidized wine</i>	CHEMANTIFN
Potassium Bicarbonate - <i>Reduces acidity</i>	CHEMPOTBIC
Protoclar K - <i>Potassium Casaine Assists in clarifying</i>	CHEMPOTCAS
Citrosol - <i>To restore wine bouquet &amp; prevent oxidation</i>	CHEMCIROKG
Disacidificante Bianco Neve - <i>Reduces/drops acid in wine</i>	CHEMBIANCA

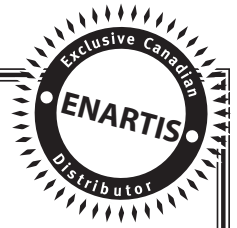

**Buon Vino is the EXCLUSIVE CANADIAN distributor for Enartis**

*Many of the chemical products listed here are imported from Enartis, an Italian manufacturer, who deals exclusively with wineries throughout Europe. All products are specially blended for optimum results.*



# Buon Vino

2021-2022

Wholesale Price List

28

PHONE 519-622-1166 TOLL FREE 1-855-522-1166

EMAIL [orders@buonvino.com](mailto:orders@buonvino.com) WEBSITE [www.buonvino.com](http://www.buonvino.com)

## Ordering:

Please use Product Codes when ordering.

## Return Policy:

Returns will only be accepted subject to approval by Buon Vino. A re-stocking charge may apply.

## Shipments:

Please check your order for any visible signs of damage. If you sign saying it was received in good condition then a shipment claim cannot be filed with the shipping company.

## TIPS ON FILTERING

### Troubleshooting Your Filters: Mini Jet, Super Jet, 6 Pad Wine Filter, and 10 Pad

- 1) Clean your machine before and after use. It is recommended that you flush 5 gallons of clean water through the pump before and after use. It is a good idea to use warm water to clean out the machine. This should help to release residual sugar.
- 2) Are your filter pads in properly? Ensure that all holes on the unit and pads are lined up.  
SUPER JET – coarse side of the pad faces the motor.  
MINI JET – coarse side of the pad faces the handwheels.
- 3) Did you wet your filter pads in recommended solution before inserting them into the machine?  
This allows the plates to create a seal around the outside of the pad when you tighten down on the plates.
- 4) Lubricate these parts with petroleum jelly (Vaseline).  
This will allow you to create a good seal on the filter pads.  
SUPER JET – front tightening screw.  
MINI JET – tightening screw threads on the 2 bolts for the handwheels.

